



The Photline ModBox-FE is a complete front end laser system designed to be used as a seed source in high energy density laser facilities. The system is available at 1030 nm, 1053 nm and 1064 nm , it allows to generate 125 ps to 10 ns, custom shaped optical pulses with high stability and high extinction ratio. The short pulse generation is based on the combination of a high performance continuous laser source combined with a large bandwidth modulation stage based on a high extinction ratio external LiNbO₃ modulator.

An automatic bias control circuitry (MBC) guarantees the extinction ratio stability over time and the optical pulses are carved out thanks to a high resolution Arbitrary Waveform Generator. A multi year collaboration experience with famous intense laser facilities all over the world allows Photline to propose high performance, reliable and easy to use systems perfectly suited to the various applications related with high energy optical pulse generation.

The ModBox-FE can be associated with the Spectral Broadening unit ModBox-SB in order to counter the SBS effects caused by the amplification of a narrow linewidth laser source.

FEATURES

- Optical waveform flexibility
- Low jitter
- Low rise & fall times
- Very high extinction ratio and stability
- Proven solution

APPLICATIONS

- Inertial confinement fusion
- Interaction of intense light with matter
- Laser plasma interaction
- Laser implosion
- Interaction of ion beam with HP laser

OPTIONS

- Extinction ratio choice
- Pulse energy

RELATED EQUIPMENTS

- ModBox-SB

Performance Highlights

| | 1030 nm | 1053 nm | 1064 nm |
|--|----------------------------|---------|---------|
| Pulse contrast | 35 dB / 55 dB | | |
| Pulse waveform | Arbitrary, user adjustable | | |
| Pulse width | 125 ps to 10 ns | | |
| Energy per pulse: PW = 1 ns & ER = 35 dB | 300 pJ | 800 pJ | 800 pJ |
| Energy per pulse: PW = 1 ns & ER = 55 dB | 100 pJ | 250 pJ | 250 pJ |
| RMS jitter | 7 ps | | |

Electrical & Optical Pulse Diagrams

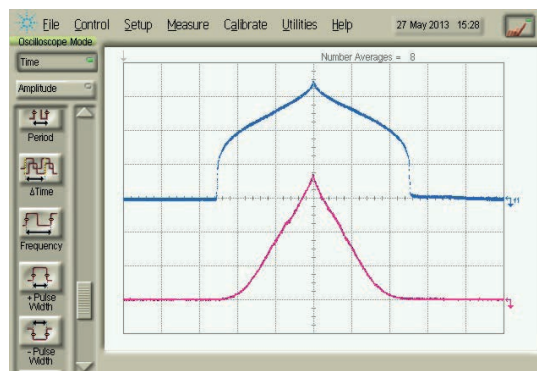

Electrical pulse from AWG (blue curve) with corresponding Optical output (pink curve)

Functional Block Diagram

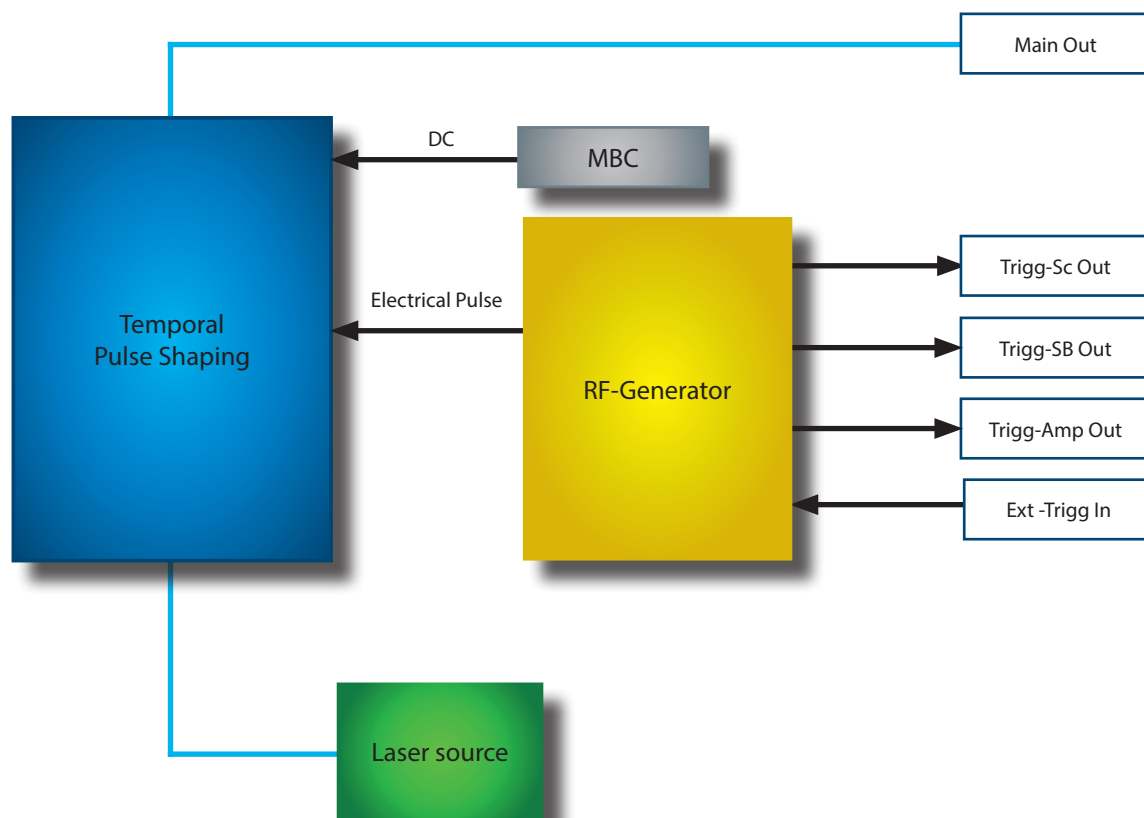

The ModBox Pulse Shaper integrates:

- a temporal pulse shaping block based on a modulator set to ensure a very high optical pulse extinction ratio (30 dB) and flexible pulse shaping,
- an automatic Modulator Bias Control circuitry (MBC) to guarantee high extinction ratio stability over time,
- a RF-Generator with an arbitrary waveform capability,
- a CW laser source.

The ModBox offers several electrical outputs and input:

- a "Trigg-Sc" : for scope synchronization,
- a "Trigg-SB" : for pulse synchronization with the ModBox-Spectrum-Broadening,
- a "Trigg-Amp" : for optical amplifier synchronization,
- an "Ext-Trigg In" : external clock input.

Input Specifications

| Parameter | Symbol | Condition | Min | Typ | Max | Unit |
|---------------------------------|--------|--|-----|-----|-----|------|
| Electrical Input Specifications | | | | | | |
| External Trigg input | - | +5 V on 50 Ω with positive slop | 0 | - | 1 | MHz |

Electrical Output Specifications

| Parameter | Symbol | Condition | Min | Typ | Max | Unit |
|---|-----------|---------------------------------------|-----|------|-----|------|
| Trigg-Sc / Trigg-SB / Trigg-Amp outputs | | | | | | |
| Delay range | - | - | 0 | - | 10 | s |
| Delay resolution | R | Trigg-Amp / Trigg-SB | - | 1 | - | ps |
| | | Trigg-Sc | - | 1.25 | - | ns |
| Delay RMS jitter | J_{RMS} | Internal trigger w/o additional delay | - | 10 | - | ps |
| | | External trigger w/o additional delay | - | - | 25 | ps |
| Delay accuracy | - | - | - | - | 150 | ps |
| Trigger delay | - | (Insertion delay) | - | - | 100 | ns |

Optical Output Specifications

| Parameter | Symbol | Condition | Min | Typ | Max | Unit |
|-------------------------------|-----------------|-------------------------------------|----------------------------|-----|-------|-----------|
| Operating wavelength | λ | - | 1030 nm, 1053 nm, 1064 nm | | | |
| Wavelength tunability | $d\lambda$ | By temperature | - | - | 0.7 | nm |
| Line-width | $\Delta\lambda$ | - | 70 kHz or 1 MHz | | | - |
| Output pulse shapes | - | - | Arbitrary, user adjustable | | | |
| Sample rate | - | - | 8 | - | - | Gsample/s |
| Number of samples | - | Per pulse | - | 800 | - | - |
| Pulse width | PW | Remotly adjustable | 125 p | - | 100 n | s |
| | | Optimized value | - | 10 | - | ns |
| Frequency repetition rate | FRR | Adjustable by the trigger frequency | 1 | - | 100 k | Hz |
| | | Optimized value | - | 10 | - | Hz |
| Rise time / Fall time | t_r/t_f | 20 % - 80 % | - | 35 | 50 | ps |
| Pulse extinction ratio | SER | - | > 30 dB or > 55 dB | | | - |
| Extinction ratio stability | ΔSER | Over 12 hours | - | - | 1 | %rms |
| Polarisation extinction ratio | PER | - | 25 | 29 | - | dB |
| RMS jitter | J_{RMS} | - | - | 7 | 10 | ps |
| Optical return loss | ORL | - | 40 | - | - | dB |
| Pulse energy | E | Rectangular pulse shape of 1 ns | 100pJ, 250pJ, 300pJ, 800pJ | | | - |
| Pulse energy stability | ΔE | Based on rectangular pulse shape | - | - | 1 | %rms |

Panels

| Parameter | Condition | Min | Typ | Max | Unit |
|--------------------------|-----------------|-----------------------------|-----|-----|------|
| Front Panel | | | | | |
| Interface | AWG, MBC | Smart interface with keypad | | | |
| Remote control connector | AWG & MBC | USB | | | |
| | Delay Generator | Ethernet | | | |

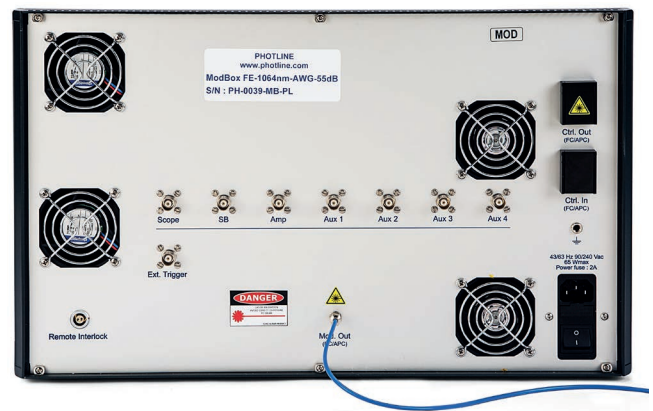

| Parameter | Condition | Min | Typ | Max | Unit |
|-------------------------|--------------------------------------|--|-----|-----|------|
| Rear panel | | | | | |
| Optical ports | "Main Out" | FC/APC, 2 meters fiber long | | | |
| Optical fiber | - | Polarization maintaining fiber, Corning PM 98-U25A | | | |
| Trigg output connectors | "Trigg SB" "Trigg Amp" "Trigg Scope" | BNC | | | |
| Trigger input connector | "Ext Trigg In" | BNC | | | |

Dimensions

| Parameter | |
|--------------|--|
| Size | 19 inches 5U (6U max) |
| Weight | 8 kg |
| Power supply | 100 - 120 V / 220 - 240 V automatic switch, 50 - 60 Hz |

ModBox Electrical and Optical Outputs

The following equipment was used to obtain below results:

- ModBox-Pulse-Shaper with built-in AWG
- Oscilloscope Agilent 86100B
- Tektronix CSA 8000 oscilloscope

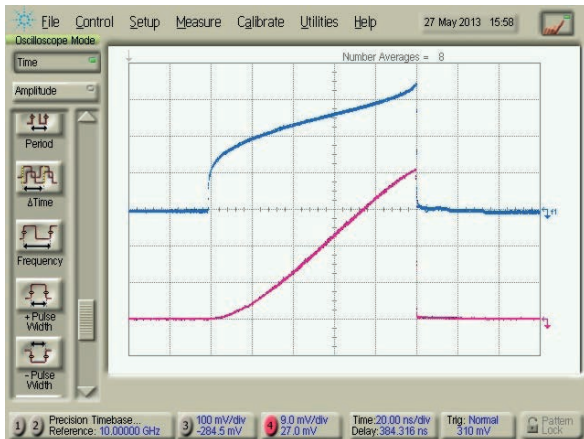

Electrical pulse from AWG (blue curve) with corresponding Optical output (pink curve)

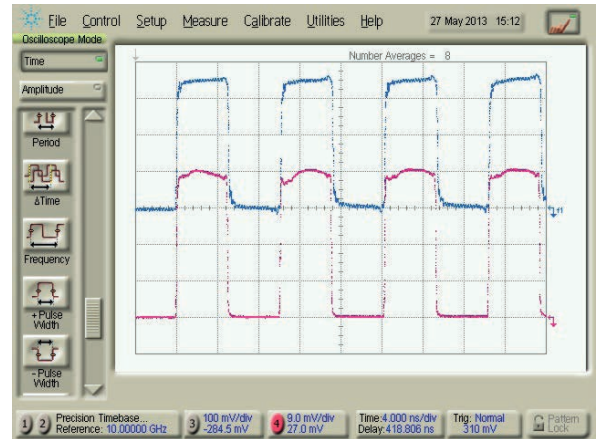

Electrical pulse from AWG (blue curve) with corresponding Optical output (pink curve)

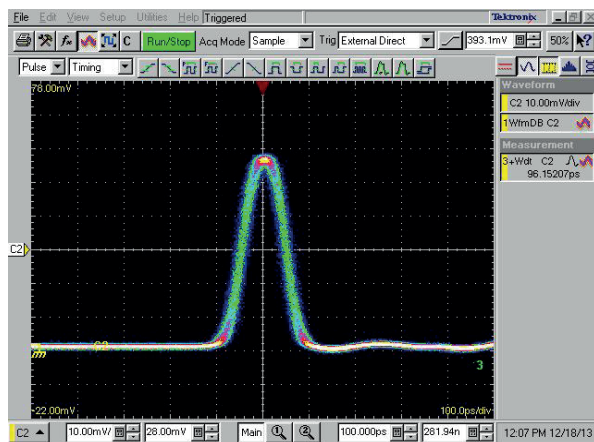

100 ps optical pulse

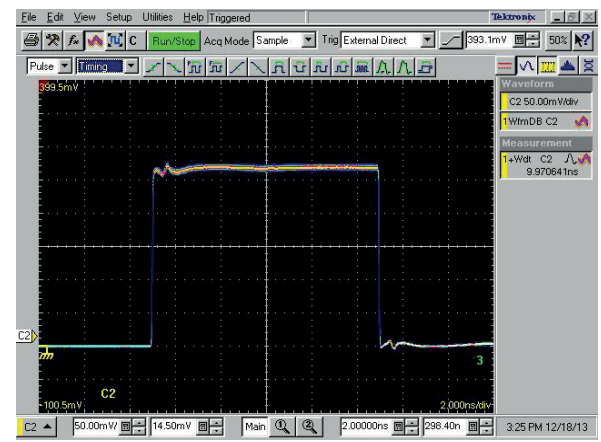

10 ns optical square pulse

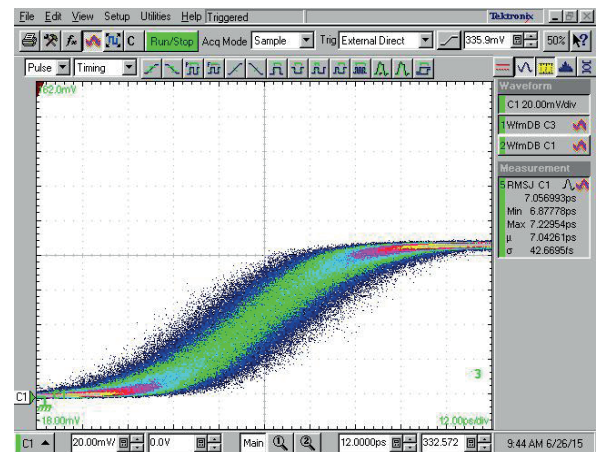
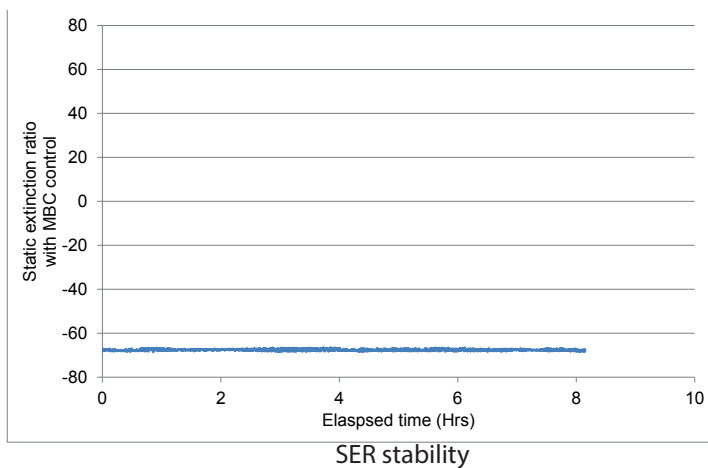

7 ps Jitter and rise time measurements

Related equipments

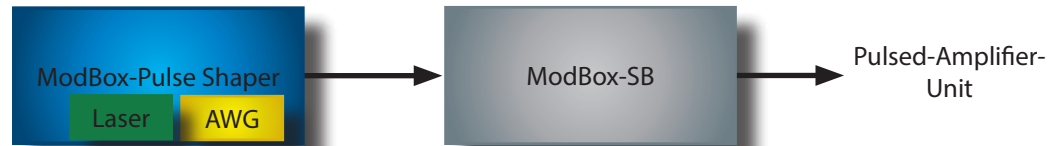

The Photline spectral broadening of optical signals is a solution to suppress the Stimulated Brillouin Scattering (SBS) caused in optical fibers by high fluxes of highly coherent light. The SBS degrades the signal integrity and prevents the proper transmission through the fiber. Under certain conditions, when amplification occurs for instance, the SBS can lead to the destruction of the fiber and the optical components along or forward the fiber. When the temporal coherence of the signal is destroyed, the SBS power threshold is significantly increased and thus its effects can be eliminated.

The Photline Modbox-Pulse-Shaper is an Optical Modulation Unit to generate short bespoke shaped pulses with high extinction ratio at 1030 nm, 1053 nm or 1064 nm. It allows dynamic extinction ratio from 35 dB to above 55 dB with user adjustable pulse duration, repetition rate and temporal pulse shape. One benefit of the Photline Modbox-Pulse-Shaper is to pre-compensate the pulse distortion that occurs in the amplifiers chains that operate in (a highly) saturated regime.

Ordering information

ModBox-FE-WL-125ps-ER-EN

- FE = Front-End Arbitrary Optical Pulse Generator
- WL = Wavelength: 1030nm, 1053nm, 1064nm
- 125ps = from 125 ps pulse width
- ER = Extinction Ratio: 30dB, 60dB
- EN = Energy per 1 ns pulse: 100pJ, 250pJ, 300pJ, 800pJ

About us

ixBlue Photonics includes ixBlue ixFiber brand that produces specialty optical fibers and Bragg gratings based fiber optics components and ixBlue Photline brand that provides optical modulation solutions based on the company lithium niobate (LiNbO₃) modulators and RF electronic modules.

ixBlue Photonics serves a wide range of industries: sensing and instruments, defense, telecommunications, space and fiber lasers as well as research laboratories all over the world.

3, rue Sophie Germain
25 000 Besançon - FRANCE
Tel. : +33 (0) 381 853 180 - Fax : + 33 (0) 381 811 557

ixblue reserves the right to change, at any time and without notice, the specifications, design, function or form of its products described herein. All statements, specification, technical information related to the products herein are given in good faith and based upon information believed to be reliable and accurate at the moment of printing. However the accuracy and completeness thereof is not guaranteed. No liability is assumed for any inaccuracies and as a result of use of the products. The user must validate all parameters for each application before use and he assumes all risks in connection with the use of the products